

55PD V2
55 LBS THRUST
12 VOLT 50 AMPS
54" OR 48" SHAFT

for use with "AI" serial numbers
3-year warranty from the date of purchase

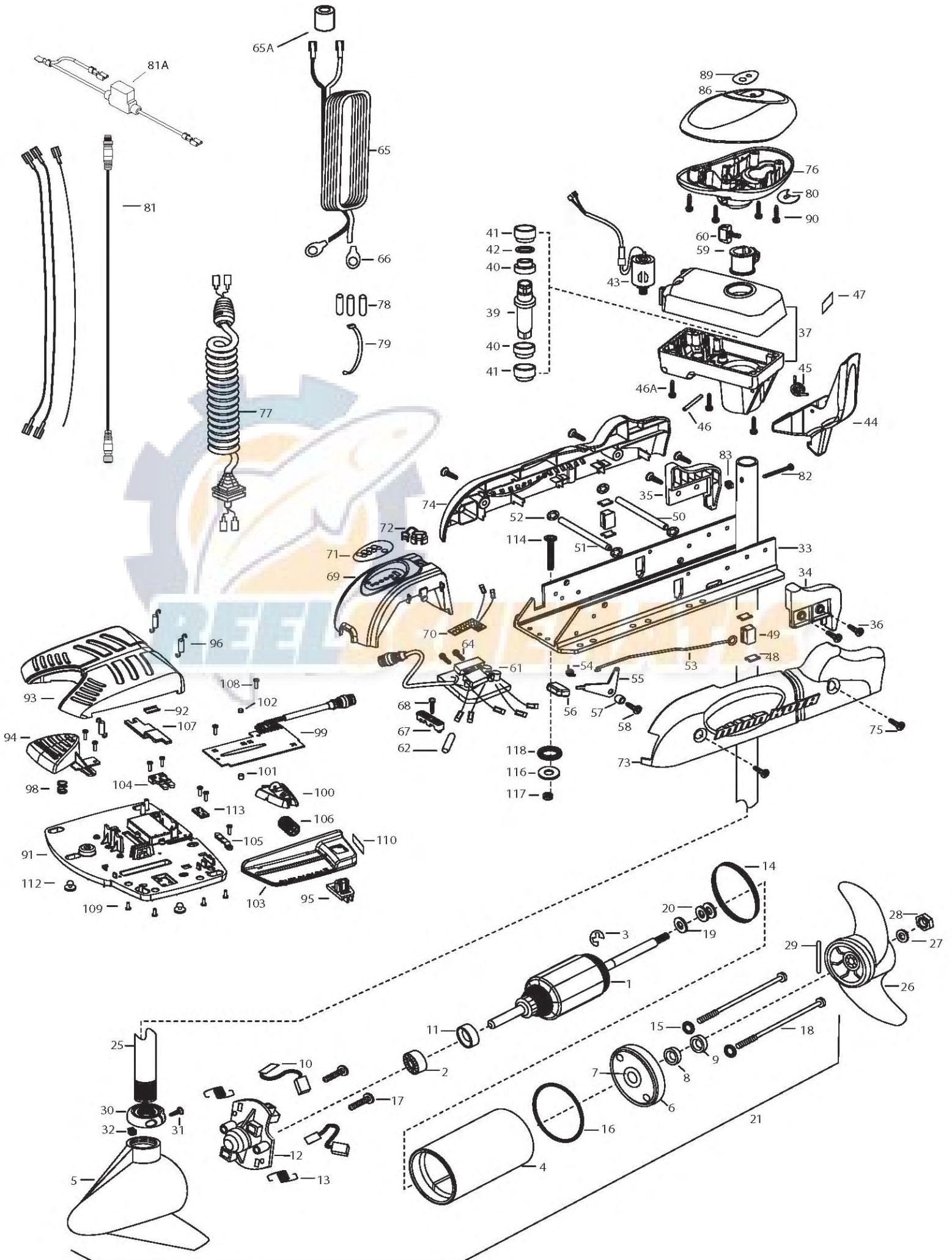

1	2-100-115	ARMATURE ASSEMBLY 12V VARS TXT	*40	2307304	BUSHING- INNER [2.EA]	80	2224702	INSERT- PLUG
2	140-010	BALL BEARING	*41	2307305	BUSHING- OUTER [2.EA]		2224700	INSERT- PLUG US2
3	788-015	RETAINING RING	*42	2304603	O-RING	81	2211415	EXTENSION CABLE US2
4	2-200-101	HOUSING ASSEMBLY CENTER 3.62 TXT	43	2307050	MOTOR- DRIVE HOUSING HIGH SPD	82	2033400	SCREW-10-24 X 1-3/4 PPH Z/P
5	421-065	HOUSING -BRUSH END 3.62 TXT	44	2307201	LATCH HANDLE PD/AP	83	2013110	NUT-HEX 10-24 ZCP
	9421-167	HOUSING -BRUSH END 3.62 US2 48"	45	2302750	SPRING- LATCH TORSION PD/AP	84	2218200	FUSE HOLDER, US2 MOTORS ONLY
	9421-168	HOUSING -BRUSH END 3.62 US2 54"	46	2302627	PIN- ROLL ZINC	86	2300237	CONTROL BOX COVER- POWERDRIVE
6	2-400-101	PLAIN END HOUSING ASSEMBLY 3.625	46A	2303407	SCREW - DRIVE HOUSING [6 EA]	89	2315682	DECAL- COVER 55PD
7	144-049	BEARING - FLANGE (SERVICE ONLY)	47	2305564	DECAL-STOW/DEPLOY		2315687	DECAL - COVER 55 PD / US
8	880-003	SEAL	48	2305110	PAD-PIVOT SUPT [4.EA]	90	2012100	SCREW-8-18 X 5/8 THD CUT [4.EA]
9	880-006	SEAL WITH SHIELD	49	2305103	PIVOT PAD- NEW MTR'L [2.EA]	■	2994725	FOOT PEDAL ASSEMBLY
10	188-036	BRUSH ASSEMBLY [2.EA]	50	2300500	PIN-LATCH	91	2304505	FOOT PEDAL BASE
11	725-050	BRUSH RETENTION- PAPER TUBE	51	2300510	PIN-PIVOT	92	2308501	WEAR PLATE FOOT PDL
12	738-036	BRUSH PLATE W/HOLDER	52	2013100	NUT-SPEED [4.EA]	93	2300255	FOOT PEDAL, CORDED UPPER
13	975-040	SPRING - TORSION [2.EA]	53	2303612	ROD-RELEASE RT/AP S	94	2303723	BUTTON, MOMENTARY
14	337-036	GASKET	54	2322700	SPRING-RELEASE LEVER	95	2303722	BUTTON, MOM/CON
15	701-008	O-RING, THRU-BOLT [2.EA]	55	2303710	LEVER-RELEASE	96	2302730	SPRING-LONG-UPPER PEDAL [3.EA]
16	701-081	O-RING	56	2300101	RELEASE-KNOB	98	2302732	SPRING-LOWER PEDAL
17	830-007	SCREW-8-32 [2.EA]	57	2301700	SPACER-RELEASE LEVER	99	2304052	CONTROL BOARD ASSEMBLY-FT PDL
18	830-042	THRU-BOLT 10-32X8.83 [2.EA]	58	2303430	SCREW-1/4-20 X 5/8	100	2308620	SLIDER, SPEED
19	990-067	WASHER- STEEL THRUST	59	2031522	COLLAR- DRIVE (W/INSERT)	101	2308409	MAGNET, 1/4 X 1/4
20	990-070	WASHER - NYLATRON [2.EA]	60	2011365	SCREW-COLLAR/NEW KNOB	102	2308408	MAGNET, 1/4 X 1/8
21	2097090	MOTOR ASSEMBLY 12V 3.62 54"	61	2304055	CONTROL BOARD ASSEMBLY- 12V PD	103	2300252	COVER, SPEED SELECTOR
	2107096	MOTOR ASSEMBLY US2 12V 3.62 VARS 54"	62	2355410	SHRINK TUBE-3/8 ODX2	104	2308606	SWITCH, DOUBLE FINGER
25	2032076	TUBE-CARBON COMPOSITE 54"	64	2303434	SCREW-8-32 X 5/8 [3.EA]	105	2308608	SWITCH, SINGLE FINGER
	2032075	TUBE-CARBON COMPOSITE 48"	65	2090651	LEADWIRE IOGA 44"	106	2307900	WHEEL, SPEED
■	1378131	PROPELLER KIT	65A	2307310	BEAD - FERRITE (CE MODELS ONLY)	107	2308625	SLIDER, STEERING
26	2091160	PROPELLER W/WEDGE 2	66	2020700	TERMINAL RING [2.EA]	108	2302100	SCREW-6-20 X 1/2 [9.EA]
27	2151726	WASHER-5/16 SS	67	2321310	STRAIN RELIEF- BRACKET PD/AP	109	2372103	SCREW-6.20 X 3/8 [4.EA]
28	2053101	NUT-PROP NYLOC	68	2323405	SCREW-1/4-20 X 5/8	110	2316600	DECAL, ON/OFF SWITCH
29	2092600	PIN-DRIVE	69	2306555	HOUSING- CENTER PD/AP	112	2994859	BAG ASSEMBLY- 5 RUBBER BUMPERS
30	2301545	COLLAR- LATCH PD/AP	70	2074070	BATTERY GAUGE - 12 VOLT	113	2302907	STRN RLF PD FP
31	2303434	SCREW- 8-32X5/8 MACH PHCR	71	2316605	DECAL, BATTERY GAUGE	■	2994864	BAG ASSEMBLY- (BOLT,NUT,WASHERS)
32	2303112	NUT 8-32 NYLOC SS	72	2302935	STRAIN RELIEF-DR. HOUSING	*114	2263462	BOLT-MOUNTING-1/4X2 W/STG [6.EA]
33	2301934	EXTRUSION- BASE MACHINED	73	2303960	SIDEPLATE (RIGHT)PD MK	*116	2261713	WASHER-1/4 [6.EA]
34	2303932	MOTOR REST- RIGHT 3-5/8	74	2303965	SIDEPLATE(LEFT)PD MK	*117	2263103	NUT NYLOK 1/4-20 MTG [6.EA]
35	2303937	MOTOR REST- LEFT 3-5/8	75	2303430	SCREW-1/4-20 X 5/8- [4.EA]	*118	2301720	WASHER-MOUNTING RUBBER [6.EA]
36	2303430	SCREW 1/4-20X5/8 SELF TAP [4.EA]	76	2302515	CONTROL BOX PD/AP			
37	2771826	DRIVE HOUSING / LATCH HANDLE ASSY	77	2991280	COIL CORD WSTRAIN RELIEF 48, 54"			
■	2882011	BUSHING/ OUTSHAFT KIT (INCLUDES 39-42)		2991282	COIL CORD WSTRAIN RELIEF 60"			
*39	2302010	DRIVE HOUSING OUTPUT SHAFT	78	2065400	WIRE INSULATOR-LGE 1-3/4 [3.EA]			
			79	2256300	TIE WRAP-5" BLACK			

2888460 seal & oring kit

55 PowerDrive is 12-volts only!!!

